

Reductions in Aprotic Media. 2. Influence of Catalytic Hydrogen Reduction on the Course of Hydrocarbon Reduction

Stanley Pons* and S. B. Khoo

Contribution from the Department of Chemistry, University of Alberta, Edmonton, Alberta, Canada T6G 2G2. Received September 28, 1981

Abstract: The reduction of polycyclic aromatic hydrocarbons at platinum electrodes in aprotic solvents does not normally occur before surface hydrogen is reduced. The reduced hydrogen reacts with the hydrocarbon before the anion radical can be formed. The intermediate species formed after electron transfer are easily observed at very low concentrations by using modulated specular reflectance spectroscopy (MSRS).

The technique of modulated specular reflectance spectroscopy (MSRS) is a powerful spectroelectrochemical technique with the advantages of simplicity, high resolution speed (microsecond), sensitivity (presently on the order of 10^{-17} mol cm^{-2}), and full continuous spectral coverage (infrared (EMIRS) to ultraviolet).¹⁻¹² We have used the technique on a millisecond time scale to elucidate certain heterogeneous processes at a platinum electrode that heretofore have been observed but not understood.

The incorporation of hydrogen gas into metal lattices is a process that is well-known.¹³ This process will occur to various extents with metal electrodes that are used to evolve hydrogen in an electrochemical cell. The process will also occur in certain metals that are merely exposed to an atmosphere containing hydrogen gas. The diffusion of hydrogen into palladium has been extensively studied.¹⁴ Sorption of hydrogen into platinum substrates occurs readily¹³ and is of particular interest because of its wide use in electrochemical kinetic studies and preparative electrolysis work.

Fleischmann et al. have recently reported the formation of hydride ion at electrodes in aprotic media.¹⁵⁻¹⁷ This process was found to be operative in a variety of cathodic reduction reactions, including those leading to carbanion formation from weakly acidic compounds. We have reported evidence for similar intermediates at the cathodic reduction limit in acetonitrile.¹⁸ These results

imply kinetic competition by hydrogen for electrons with any reaction normally occurring at high negative potentials. The hydrogen is present at the interface by virtue of internal diffusion to the surface from the metal lattice.

Electrochemists have noted the generally poor reproducibility and nonreversibility of various electrode kinetic measurements in aprotic media at platinum electrodes at high negative potentials.²⁰⁻²² The same reactions, many times, are much more well-behaved under identical conditions at a vitreous carbon, mercury, or lead cathode, electrodes that have a high hydrogen overpotential.^{13,19}

In this work, we consider one common class of cathodic organic reactions and show that surface hydrogen reduction can severely complicate kinetic measurements at a platinum electrode. Such a mechanism is the cathodic reduction of polynuclear aromatic hydrocarbons at a platinum electrode in acetonitrile or *N,N*-dimethylformamide. Kinetic and mechanistic studies on both short and long time scales have been performed for these systems.²³ In pure and anhydrous solvent/electrolyte systems that use tetraalkylammonium salts, the generally accepted mechanism in the first wave is the one-electron reduction to the π anion radical:

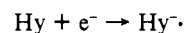

The second electron transfer, which occurs some 600 mV more negative than the first reduction, is the formation of the dianion

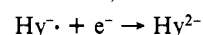

It should be noted that voltammograms of differing shapes appear in the literature for this second process.^{16,24} These differences, as we will show, can be attributed to varying degrees of catalytic hydrogen reduction and not to experimental errors.

Experimental Section

Chemicals and Solvents. Caledon "HPLC" grade acetonitrile (nominally 0.003% water) was refluxed for 2 h over calcium hydride and Woelm neutral alumina (Super Grade I) and subsequently distilled from the mixture. The dry solvent was stored over fresh alumina of the same type and under a dry argon atmosphere. The purification process was repeated if the steady-state background current at -3.00 V of a 0.1 M solution of tetrabutylammonium tetrafluoroborate at a vitreous carbon electrode exceeded $20 \mu\text{A cm}^{-2}$.

Hydrocarbons were purchased from Aldrich and recrystallized from acetonitrile before use.

Electrolyte and Reference Electrode. Tetra-*n*-butylammonium tetrafluoroborate was prepared as described in the literature,²⁵ recrystallized twice from methylene chloride/diethyl ether, and dried in vacuo at 110°C for 3 days before use.

- (1) Bewick, A.; Kunimatsu, K.; Pons, S. *Electrochim. Acta* **1980**, *25*, 465.
- (2) Bewick, A.; Mellor, J.; Pons, S. *Electrochim. Acta* **1978**, *23*, 77.
- (3) Bewick, A.; Edwards, G.; Mellor, J.; Pons, S. *J. Chem. Soc., Perkin Trans. 2* **1977**, 1952.
- (4) Bewick, A.; Mellor, J.; Pons, S. *Electrochim. Acta* **1980**, *25*, 931.
- (5) Davidson, T.; Pons, S.; Bewick, A.; Schmidt, P. *J. Electroanal. Chem. Interfacial Electrochem.*, in press.
- (6) Bewick, A.; Kunimatsu, K.; Russell, J.; Pons, S. *Electrochim. Acta*, in press.
- (7) Bewick, A.; Kunimatsu, K. *Surf. Sci.* **1980**, *101*, 11.
- (8) Bewick, A.; Tuxford, A. *J. Electroanal. Chem. Interfacial Electrochem.* **1973**, *47*, 255.
- (9) Bewick, A.; Lamy, C.; Beden, B.; Kunimatsu, K. *J. Electroanal. Chem. Interfacial Electrochem.* **1981**, *121*, 343.
- (10) Bewick, A.; Robinson, J. *J. Electroanal. Chem. Interfacial Electrochem.* **1975**, *60*, 163.
- (11) *J. Electroanal. Chem. Interfacial Electrochem.* **1976**, *71*, 131.
- (12) Bewick, A.; Thomas, B. *J. Electroanal. Chem. Interfacial Electrochem.* **1975**, *65*, 911.
- (13) See, for instance: Bockris, J.; Reddy, A. "Modern Electrochemistry"; Plenum Press: New York, 1978; Vol. II, p 1338.
- (14) See for instance: Jost, W. "Diffusion in Solids, Liquids, Gases"; Academic Press: New York, 1960, and references therein.
- (15) Fleischmann, M.; Mashader, D. *Electrochim. Acta*, in press.
- (16) Fleischmann, M.; Mashader, D.; Tabakouik, I. *Electrochim. Acta*, in press.
- (17) Fleischmann, M.; Mashader, D. *Electrochim. Acta*, in press.
- (18) Pons, S.; Khoo, S. *Electrochim. Acta*, in press.
- (19) Avaca, L.; Bewick, A. *J. Electroanal. Chem. Interfacial Chem.* **1973**, *41*, 405.

- (20) Maloy, J.; Prater, K.; Bard, A. *J. Am. Chem. Soc.* **1971**, *93*, 5959.
- (21) Bard, A., private communication.
- (22) Demortier, A.; Bard, A. *J. Am. Chem. Soc.* **1973**, *95*, 3495.
- (23) For a review, see: Peover, M. In "Electroanalytical Chemistry"; Bard, A., Ed.; Marcel Dekker: New York, 1967; Vol. II.
- (24) Dietz, R.; Larcombe, B. *J. Chem. Soc. B* **1970**, 1369.
- (25) Lund, H.; Iverson, P. In "Organic Electrochemistry"; Baizer, M., Ed.; Marcel Dekker: New York, 1973.

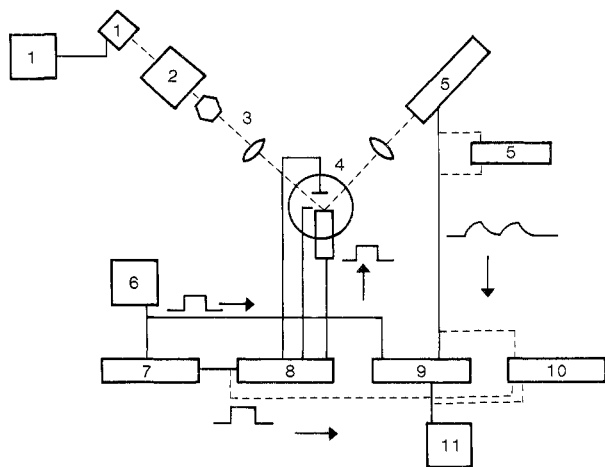

Figure 1. MSRS experimental arrangement: (1) lamp and lamp power supply; (2) monochromator; (3) filtering and focussing optics; (4) cell (see Figure 2); (5) photodetector and power supply; (6) oscillator trigger; (7) waveform generator; (8) potentiostat; (9) lock-in amplifier for spectral measurements; (10) signal averager for transient measurements; (11) data storage.

The reference electrode was made from a silver wire immersed in this electrolyte (0.1 M in acetonitrile), which also contained 0.01 M Ag^+ - NO_3^- .

Modulated Specular Reflectance Spectroscopy.¹⁻¹² The experimental arrangement is shown in Figure 1. The light from a Hanovia 200-W Hg/Xe lamp driven by a constant-current stabilized power supply was focused onto the entrance slit of a GCA 270 monochromator. The monochromator output, after filtering, was focused onto a mirror electrode mounted in a cell (see below). The reflected light was collected and focused onto an EMI 9558 QB photomultiplier tube, and the signal was sent to either a lock-in amplifier system for recording of spectra or to a digital signal averager for recording absorbance-time transients. An automatic feedback system was used and *relative* spectral absorbances were recorded to compensate for differences in lamp intensity at various wavelengths and the changing response of the detector with wavelength and time. This was accomplished by feeding back the lamp intensity into a programmable power supply for the photomultiplier. The photomultiplier was controlled at constant current by a current-sensitive amplifier, whose integrated output was the feedback source for the programmable power supply.

The electrode was square wave modulated between two potentials. The lower (base) potential was such that no faradaic process was occurring at the working electrode. The higher potential was chosen such that diffusion-limited reduction in the first voltammetric wave was effected. If the wavelength of light incident on the electrode corresponds to absorption wavelengths of the reduced product(s), then the incident light will be modulated on passage through the reaction layer at the same frequency of modulation at which the electrode is being subjected. If the wavelength is scanned while the signal was recovered with a lock-in amplifier, the output of the amplifier is a normalized differential absorbance spectrum of the substances in the electrochemical diffusion/reaction layer near the electrode surface. After a spectrum is obtained, it is then possible to follow the kinetics of formation and decay of the individual intermediates or products. By operating at a single wavelength corresponding to an absorption maximum of a product of interest, an absorbance-time transient of the species is obtained by using a signal averager on the detector output instead of a lock-in amplifier. In normal operation, the wave form generator simultaneously triggers the potentiostatic step at the electrode and the signal averager on the detector.

The electrode was housed in a quartz/glass cell, which is shown in Figure 2. The electrode material was 6 mm in diameter and was polished to a mirror finish with 0.05- μm alumina. The electrode was mounted in the end of a 9-mm diameter Kel-F rod so that the 6-mm disk face was exposed to the solution. A Luggin capillary reference probe was inserted through a ground-glass joint in the top of the cell, and the tip was adjusted so that the working electrode gave the sharpest response possible to a square-wave input without oscillation. This was typically set up in a 0.1 M tetrabutylammonium tetrafluoroborate solution pulsing between 0.00 and -1.00 V vs. Ag/Ag^+ . The monochromatic light entered the cell through a 1-cm quartz window mounted in a glass tube, whose axis was oriented at a 45° angle to the electrode disk face. Reflected light exited the cell through an identical window arrangement on the opposite side of the cell. The light beam was focused so that the entire electrode

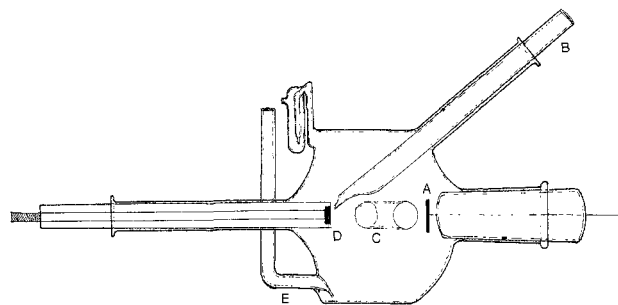

Figure 2. MSRS kinetic cell: (A) secondary electrode; (B) Luggin reference probe; (C) light entry/exit port (quartz window); (D) working electrode mirror; (E) purge-gas inlet.

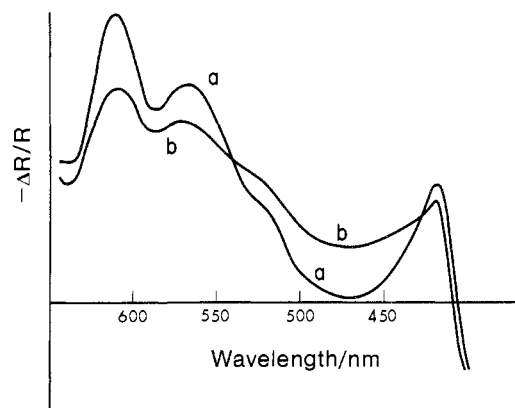

Figure 3. (a) MSRS spectrum of 1.0 mM 9,10-diphenylanthracene at a vitreous carbon electrode (in acetonitrile/tetrabutylammonium tetrafluoroborate (0.1 M), modulation frequency = 40 Hz, step 0.00 to -2.50 V). (b) Same spectrum made at a platinum mirror electrode.

face was illuminated. The cell was mounted on an optical bench and covered by a light-tight wooden box. The exit slit of the monochromator and the entrance face of the detector were mounted on adjacent walls of the box in positions such that a single reflection from the electrode resulted in the light striking the photomultiplier.

The potentiostat, waveform generator, signal averager, and lock-in amplifier system were supplied by Hi-Tek Instruments.

Results and Discussion

An MSRS spectra of 9,10-diphenylanthracene (1.0 mM) in acetonitrile at a vitreous carbon electrode is shown in Figure 3a. The modulation was from 0.0 to -2.50 V, and the frequency of modulation was 40 Hz. The spectrum is almost identical with that obtained for the anion radical by conventional transmission techniques.²⁶ The spectrum recorded by using a polished platinum electrode is shown in Figure 3b. The two spectra have obviously different absorbance characteristics.

If the anion radical is considered to be stable against electrochemical or chemical reaction over the time scale of the experiment (12.5-ms potentiostatic hold at the higher potential), then we surmise that the two spectra should be identical. The spectra obtained with the MSRS technique are differential and normalized to the spectrum of the base potential, i.e., the output of the lock-in amplifier is $(R_2 - R_1)/R_1$. R_1 is the reflectance from the electrode at the lower base potential, where no faradaic reaction occurs, and R_2 is the reflectance from the electrode at the higher potential, where the diffusion-controlled reduction of substrate occurs.^{8-10,12} The magnitude of this quantity is dependent only on the number of particles encountered by the light beam and the extinction coefficients of those particles. Thus, the spectra should be independent of electrode characteristics, such as area and intrinsic reflectivity, in the types of measurements made here. We conclude that there is no a priori reason for such large differences in the intensity of the spectra made at the two electrodes, unless there is another species being formed at the platinum electrode in the

(26) Sioda, R. *J. Phys. Chem.* 1968, 72, 2322.

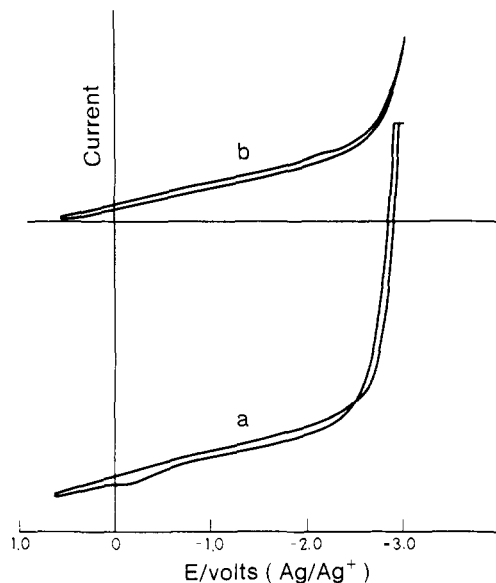

Figure 4. (a) Cyclic voltammogram at a platinum mirror electrode of the pure acetonitrile/tetrabutylammonium tetrafluoroborate (0.1 M) system ($v = 100 \text{ mV s}^{-1}$). (b) Same as Figure 4a except at a platinum mirror electrode that was preanodized at +1.00 V for 30 s.

diffusion layer on the time scale being used.

The cyclic voltammogram of the pure solvent/electrolyte is shown in Figure 4a. We do not note significant faradaic reduction occurring at -2.50 V in this rather standard electrochemical system at a platinum electrode. The background is, however, slightly larger than that at a vitreous carbon electrode. Therefore, we recorded MSRS spectra of the blank electrolyte solutions at both electrodes. The results in each case were identical—flat, featureless spectra with zero measured absorbances when measured at the same sensitivities as the earlier spectra. Apparently, the “extra” absorbance noted below 550 nm only occurs at platinum electrodes when the substrate is present. This raises the question of what other 9,10-diphenylanthracene species could be formed at -2.50 V other than the anion radical and only at the platinum electrode. Since existence of another such species is not very likely, we ran the same experiments in dimethylformamide containing the same electrolyte and recorded the same results as those obtained in acetonitrile. The supporting electrolyte was changed to tetrabutylammonium perchlorate in both solvents and then tetraethylammonium perchlorate in both solvents. The results were again the same. Substrates were changed to naphthalene, anthracene, and 9,10-dimethylanthracene in all solvent electrolyte systems, and parallel results were again obtained. We conclude that platinum electrodes, in general, always tend to alter the standard literature spectra of aromatic hydrocarbon anion radicals and seem to introduce at least one extra absorbing species. Since the results from these steady-state spectra are rather limited, we used MSRS in a time-dependent mode (signal averaging) to gain further information.

It should be pointed out at this point that although time information can be extracted from lock-in amplifier output signals, the procedure would be extremely difficult in this experiment, since the nature of lifetimes of any new species found is unknown. Therefore, with possible kinetic complications to be considered, a much simpler approach is simply to look at the absorbance-time transients of the reduction products at appropriate wavelengths. For a stable reduction product formed under the described conditions that absorbs light at the chosen wavelength of incident radiation, we have

$$\frac{R_2 - R_1}{R_1} = \frac{4\epsilon C^0 (D_0 t)^{1/2}}{\pi^{1/2} \cos \theta} \quad (1)$$

C^0 is the bulk concentration of substrate, ϵ is the molar extinction coefficient, D_0 is the diffusion coefficient of substrate, θ is the angle of incidence of the radiation, and t is the time. When

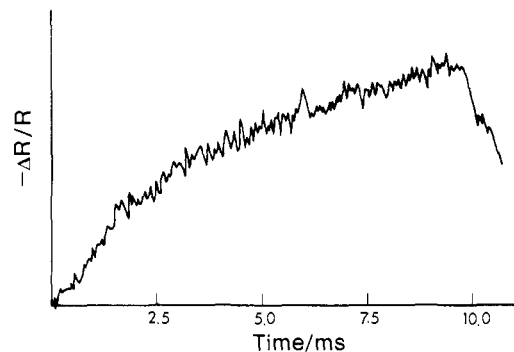

Figure 5. Absorbance-time transient at 612.5 nm at a vitreous carbon electrode of 9,10-diphenylanthracene (1.0 mM in acetonitrile/tetrabutylammonium tetrafluoroborate (0.1 M), 256 scans).

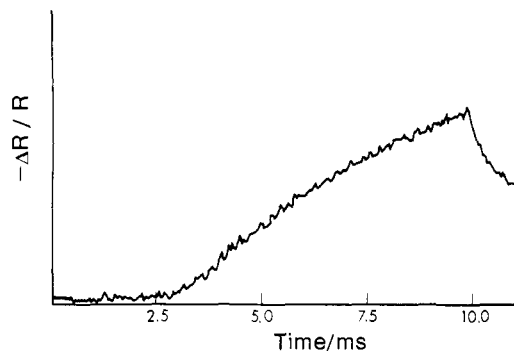

Figure 6. Same as Figure 5 except at a platinum mirror electrode.

subsequent chemical reactions affect the primary radical products, more complex equations and techniques may be used to observe and describe the kinetics of the process.²⁻⁴

Pulse trains (10 ms at -2.50 V , 300 ms at 0.00 V) were applied to the electrodes and the absorbance-time transient recorded. The result for the vitreous carbon electrode in acetonitrile/tetrabutylammonium tetrafluoroborate containing 1 mM 9,10-diphenylanthracene is shown in Figure 5. The wavelength is 612.5 nm . This corresponds to one of the absorption maxima of the anion radical of the substrate. The shape of the curve is as expected for the appearance of a stable one-electron reduction product formed from a species being transported to the electrode under diffusion-controlled conditions, i.e., eq 1.

The absorbance-time transient of the same solution at a platinum electrode is shown in Figure 6. The transient is considerably different from that obtained at vitreous carbon. The light absorbed is less all across the transient, indicating fewer anion radical particles in the diffusion layer. This is in accordance with the spectra in Figure 3. The differential reflectance (abscissa) values in Figure 3 are proportional to the root-mean-square value of many absorbance-time transients. The other noticeable feature is the delay of some 3 ms before the transient begins to rise appreciably. After the transient begins its rise, it is essentially the same as the transient observed at the vitreous carbon electrode. Conventional electrochemical techniques give no indication of this delay process. We have performed chronoamperometric and chronocoulometric experiments on the system and agree with the results reported by Bard²⁷ for the same system in dimethylformamide. There are apparently no adsorption processes occurring in the system, and no other heterogeneous process is indicated. Electrochemical results indicate a single diffusion-controlled process involving the hydrocarbon substrate.

If we assume, for the moment, that some other species is being formed at the electrode surface that *does not* absorb light at this wavelength, then the situation is remedied. We imagine a competition for electrons between another reducible species and the

(27) Hazelrigg, M.; Bard, A. J. *Electroanal. Chem. Interfacial Chem.* 1973, 46, 141.

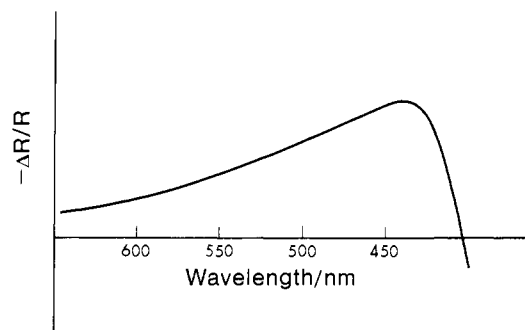

Figure 7. Same as Figure 3b except with a 1.0-kHz modulation frequency.

9,10-diphenylanthracene, where the other reducible species, at least for the first 3 ms, is the one that is reduced first. The experiment to perform, then, is another MSRS wavelength scan, but at a much higher frequency, i.e., on the order of the square wave modulation where the potential is at -2.50 V for only 3 ms instead of 12.5 ms. In this situation, only the "new reducible" species should be reduced, since 9,10-diphenylanthracene does not begin to reduce until about 3 ms after the pulse is applied. To guarantee minimal interference from formation of 9,10-diphenylanthracene anion radical, we set the modulation frequency at 1 kHz (0.5 ms at -2.5 V; 0.5 ms at 0.0 V) and recorded the spectrum.

At a vitreous carbon electrode, we again get the spectrum of the 9,10-diphenylanthracene anion radical as expected. At the platinum electrode, an entirely new spectrum is obtained with apparently no anion radical present on this time scale (Figure 7). The spectrum has an absorption maximum at 440.0 nm. Control experiments were performed on the aforementioned solvent/electrolyte systems *without* hydrocarbon substrate, but the spectrum in Figure 7 could not be reproduced. The hydrocarbon must be present to get a spectrum. In addition, when other substrates were used, the absorption maximum was a function of the substrate. Naphthalene had a maximum at 437.0 nm in the acetonitrile/tetrabutylammonium tetrafluoroborate system.

Due to the electrochemical data, however, we still suspect that diphenylanthracene is being consumed at *all* times, even at these higher frequencies. We note the sharply descending nature of the spectra in Figures 3 and 7 at wavelengths shorter than 400.0 nm. These shorter wavelengths correspond to those where the substrate 9,10-diphenylanthracene absorbs radiation. Since the spectra recorded in this technique are differential in nature (eq 1), we expect a negative value for the differential reflectance when we are at wavelengths where the substrate (substance being removed at the electrode) absorbs light. We can see in Figure 7 that 9,10-diphenylanthracene is removed at the electrode even at these higher frequencies, but the initial product formed is definitely not the anion radical.

We have shown, then, that two products are formed: the anion radical (at carbon and platinum electrodes) and some other species (at platinum only, and before the anion radical). Both products originate from the substrate 9,10-diphenylanthracene, which apparently undergoes only a simple diffusion-controlled approach to the surface of the electrode.

Since we now know where the maximum absorption occurs for the new species formed at a platinum electrode, we can look at its kinetics by recording the absorbance-time transient at that wavelength. The results are shown in Figure 8. The transient at 440.0 nm is composed of two parts. The first part is due to the new species and obeys eq 1 for formation from a species transported to the surface by diffusion control. The second half of the transient is that of the anion radical, which also absorbs slightly at this wavelength.

These results are consistent with a model of rapid formation of hydride ion at the platinum surface.¹⁵⁻¹⁸ The source of the hydrogen is that absorbed in the platinum lattice. When the electrode is pulsed to high negative potentials, hydrogen at the

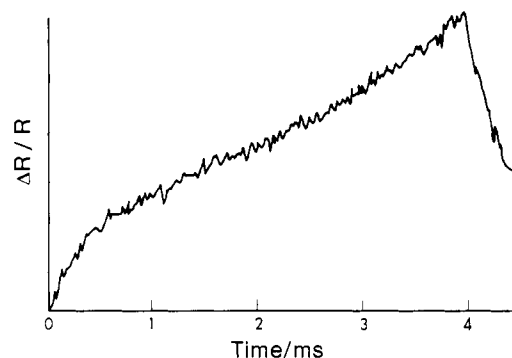

Figure 8. Same as Figure 5 except at a platinum electrode at 440.0 nm (512 scans).

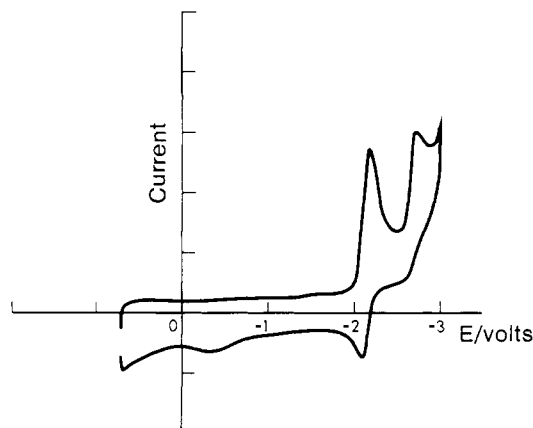
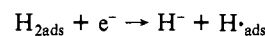
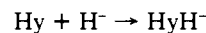

Figure 9. Cyclic voltammogram of 1.0 mM 9,10-diphenylanthracene at a vitreous carbon electrode in acetonitrile/tetrabutylammonium tetrafluoroborate (0.1 M) ($\nu = 100$ mV s⁻¹).

surface is first reduced to hydride, so the surface concentration of hydrogen is depleted. More hydrogen then diffuses from the platinum lattice and is subsequently reduced. The diffusion is slow, causing a broadened reduction wave that results in enhanced background current.



As the 9,10-diphenylanthracene diffuses to the surface when the potential is stepped to -2.50 V, there is rapid reaction with hydride



or rapid reaction of the anion radical with hydrogen atoms:

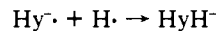

Reactions of this type are well-known from studies of sodium naphthalide with hydrogen gas.²⁸⁻³⁰ The reported absorption maximum for the naphthalide anion is 437.0 nm, precisely the same as was observed in this work for the species formed at short times.³¹

Such a mechanism implies that if all hydrogen gas were to be excluded from the platinum lattice, then the spectroelectrochemical and electrochemical properties of the two electrodes should be equivalent, all other factors (adsorption effects, resistivity, etc.) being equal.

We first look at the conventional electrochemistry to -3.00 V for the systems described. The cyclic voltammetry of 9,10-diphenylanthracene in acetonitrile solution at a carbon electrode is shown in Figure 9. Two reduction peaks are observed, with two anodic peaks appearing on the reverse scan. This classical

(28) Bank, S.; Lois, T.; Prislowsky, M. *J. Am. Chem. Soc.* **1969**, *91*, 5407.

(29) Bank, S.; Lois, T. *J. Am. Chem. Soc.* **1968**, *90*, 4505.

(30) van Tاملen, E.; Fechter, R. *J. Am. Chem. Soc.* **1968**, *90*, 6854.

(31) Ichikawa, M.; Soma, M.; Oniski, T.; Tamura, T. *Bull. Chem. Soc. Jpn.* **1970**, *43*, 3672.

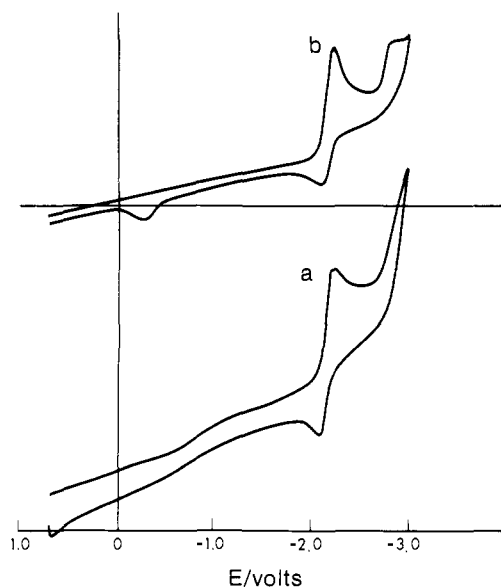
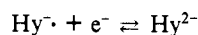
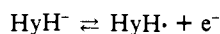

Figure 10. (a) Same as Figure 9 except at a platinum (untreated) electrode, substrate concentration 0.32 mM. (b) Same as Figure 10a after 30 s preanodization at +1.00 V.

voltammogram has been reported and analyzed in great detail by many workers.²³ For the purpose of this work, it is important to note the well-formed second reduction wave



and the oxidation of the protonated dianion at -0.35 V



at this electrode. At a platinum electrode that has been mechanically polished and exposed to the atmosphere before use, the voltammogram is quite different (Figure 10). The first reduction is reasonably well behaved. The second reduction is now pushed into the background reduction region, i.e., the usual poorly reproducible result at a platinum electrode under these conditions.

The control experiment is to eliminate hydrogen from the platinum lattice and try to force the electrochemistry into a more "classical" behavior. This was accomplished by holding the electrode at +1.00 V for 30 s. At this potential, any hydrogen near the surface should be oxidized, and depletion of the internal diffusion layer for some period of time should occur. The solution was stirred briefly with argon bubbling and the negative potential sweep repeated immediately after anodization of the electrode. The result is shown in Figure 10b. The voltammogram now has all of the well-behaved features of the vitreous carbon curve, a result that strongly supports the model. The reverse experiment was also performed. The platinum electrode was made the cathode in 1 M aqueous sulfuric acid solution for 30 s at 10 mA cm^{-2} . Hydrogen gas was vigorously evolved. The mechanism would predict a large increase in hydride production, since there should be an excess of hydrogen in the lattice near the surface. The subsequent voltammogram recorded after the electrode was dried in argon was similar to Figure 10a (untreated platinum), except that the system breakdown potential had moved about 50 mV more anodic. It should also be noted that the background cyclic

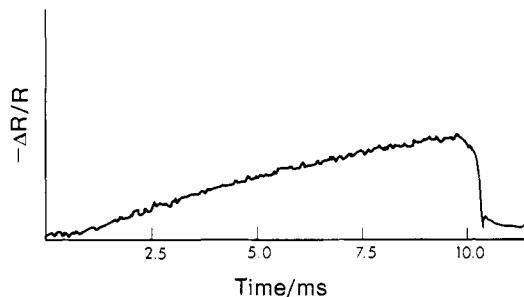

Figure 11. Same as Figure 5 except at a hydrogen-filled platinum mirror electrode.

voltammograms are also affected by such treatment as outlined above (Figure 4b). When hydrogen is removed from the electrode, there is much less residual background current in the voltammogram, and the cathodic limit of the system is greater.¹⁸

If we now consider the spectroelectrochemical MSRS results, we find that the same conclusions may be drawn. We observe the following: (1) Removal of hydrogen from the electrode by anodization at +1.00 V with subsequent 40-Hz modulation now gives a spectrum identical with the vitreous carbon spectrum (Figure 3b). (2) Absorbance-time transients recorded at this purged electrode are now also identical with those obtained at a vitreous carbon electrode. There is no evidence of any delays before the anion radical transient appears. (3) Treating the electrode in sulfuric acid (injecting hydrogen) gives spectra that are considerably decreased in intensity in the anion radical region but increased in the 440.0-nm region. (4) The absorbance-time transients are now very depressed at 612.5 nm (Figure 11). The size of the time delay is increased markedly if the transients are compared on the same vertical scale as the untreated platinum electrodes.

The results for MSRS are what we would expect in light of the electrochemical observations and the proposed mechanism. A more detailed analysis of the reaction products of hydride with the sorbent/electrolyte system under a variety of conditions has been investigated and will appear elsewhere.¹⁸

Conclusions

The reduction of hydrogen must be considered when electron-transfer kinetics at a platinum cathode at highly negative potentials are investigated. The prevention of this reaction seems to be controllable if pretreatment at positive potentials is utilized. The existence of hydride (and its prevention) in less reactive forms¹⁶ may be of consequence in practical applications, such as its influence on undesirable side reactions in lithium/sulfur dioxide cells and in cadmium/nickel containing cells.³² Work is in progress in this area.

Acknowledgment. Part of this work was supported by a grant from the Office of Naval Research, Washington, DC.

Registry No. 9,10-Diphenylanthracene, 1499-10-1; naphthalene, 91-20-3; anthracene, 120-12-7; 9,10-dimethylanthracene, 781-43-1; 9,10-diphenylanthracene radical anion, 34505-64-1; hydride, 12184-88-2; 9,10-diphenylanthracene dianion, 78851-99-7.

(32) Palanisamy, T.; Kao, Y. K.; Fritts, D.; Maloy, J. T. *J. Electrochem. Soc.* **1980**, *127*, 2535.